

## HEAVY-DUTY MODULES THP – PST





Renewable energy solutions delivered by  
**GLOBAL LOGISTICS ALLIANCE** (Pty) Ltd  
Tel: 021 9...  
www.glafr...



**ALE**  
CHARTER, SAFER, STRONGER

CF1 1492

# HEAVY HAULAGE ON ROAD AND OFF ROAD CUSTOMIZED SOLUTIONS FROM GOLDHOFER FOR MAXIMUM FLEXIBILITY

As the market leader in the field of heavy-duty modular trailers and hydrostatically powered modular transporters, Goldhofer has set itself the goal of developing individual cost-effective solutions for customers whose business involves transporting loads weighing between 50 and over 10,000 tons. We have accordingly been committed for decades to the continuous further development of our internationally acclaimed modular systems, which are deployed for all kinds of transport operations under the most demanding climatic conditions, from 50 °C in the desert to -40 °C in Siberia as well as 100 % humidity and monsoons in subtropical countries.

This is only possible in a permanent dialog with our customers, who appreciate this continuity and support us with their practical experience. As a result, we are able to continue to develop the new and economical solutions for the constantly changing transport requirements that our customers have to meet to remain successful.

Be sure to take advantage of our long years of experience in combination with the advanced technology and outstanding quality of our modular vehicles so that your fleet remains fit for the future. You will also benefit from our 24-hour customer service and extensive transport engineering services.



# CONTENTS

Technology	06	Heavy-duty modules with hydrostatic drive and mechanical steering	38
Heavy-duty modules with pivot bearings	08	PST/SL (215) twin tires (3000)	39
THP/ET (285) single tires	09	PST/H (235) twin tires (3600)	41
THP/UT (205/215) twin tires	11	Steering modes – electronic steering	44
THP/MT (215) twin tires	13	Heavy-duty modules with hydrostatic drive and electronic steering	46
Bogies: Pivot bearing/ball bearing race ring	15	PST/SL-E (215) twin tires (3000)	47
Heavy-duty modules with ball bearing race rings	16	PST/ES-E (285) single tires (2430)	49
THP/SL-S (245/285) single tires	17	PST/ES-E (315) single tires (2430)	49
THP/SL-L (215) twin tires	19	PST/ES-E (385) single tires (2430)	49
THP/SL (215) twin tires	21	Accessories PST	52
Special modules with ball bearing race rings	22	Power packs	53
THP/SL (1800) + THP/MI (215) twin tires	23	Standard accessories (remote control, driver’s cab etc.)	55
THP/HL (245) + THP/H (235) twin tires	25	Software/Engineering	56
Accessories THP	30	Service	58
Gooseneck	31		
Loading bridges (vessel deck, crawler deck, flatbed etc.)	33		
Standard accessories (swivel arm, drawbar, hydraulic power pack, remote control, etc.)	35		
+ accessories for side-by-side combinations	35		
Long-load turntable, self-tracking steering	37		

# FRAME, STEERING, HYDRAULIC SUSPENSION THE FOUNDATION, PERFECTED OVER THE DECADES



Center beam in box-section design with integrated compressed air and hydraulic oil tanks

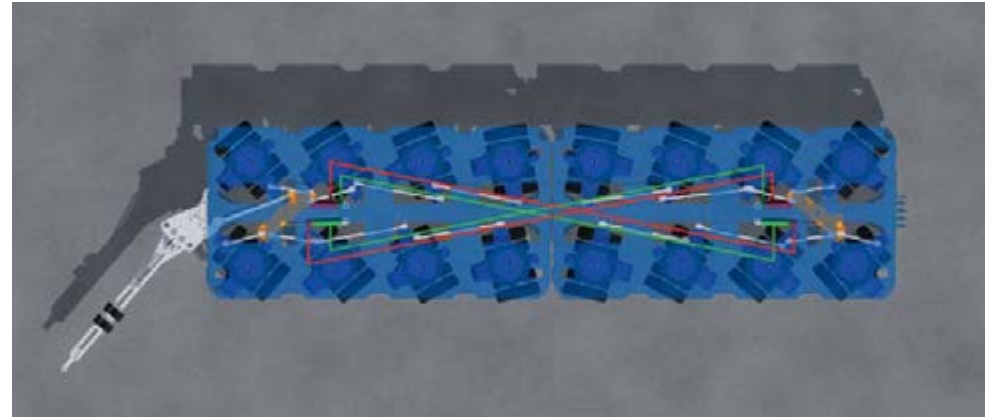

Hydromechanical steering



Hydraulic axle suspension – longitudinal

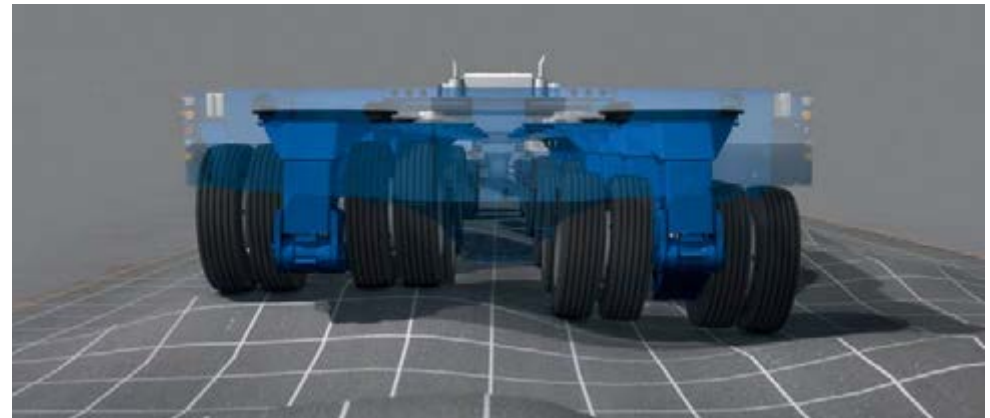

Hydraulic axle suspension – lateral + lateral swing movement

# HYDROSTATIC DRIVE, ELECTRONIC MULTIWAY STEERING THE BASIS FOR PRECISION AND RELIABILITY

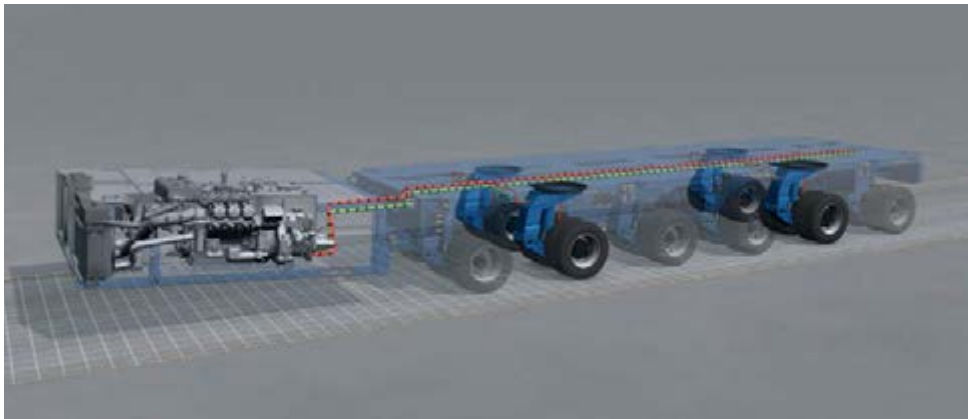

Hydrostatic drive



Hydrostatic drive



Electronic multiway steering



Electronically steered wheel set

Heavy-duty modules with pivot bearings





# TYPE THP/ET

## PERFORMANCE FOR MAXIMUM MILEAGE

### Range of applications: Public roads and construction site operations

- 2500 mm alternative width for excellent maneuverability
- Optimum payload/axle load ratio

### Maximum mileage and minimum wear

- 19.5" axle and brake system

### Technical features

- Single tires 285/70 R 19.5
- Axle load 23t at 10 km/h

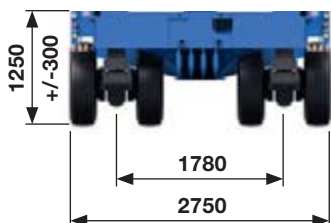
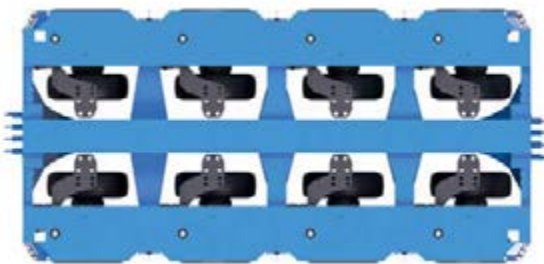
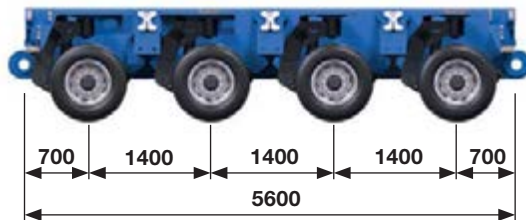

Heavy-duty modules with pivot bearings



# TYPE THP/UT

## MINIMUM LOADING HEIGHT FOR MAXIMUM REQUIREMENTS

### Range of applications: Public roads

- 2750 mm alternative width for excellent maneuverability
- Mechanical width adjustment by means of spacers THP/UT split (1800)
- Optimum payload/axle load ratio

### Optimized for high loads

- Lowest loading height

### Technical features

- Twin tires 205/65 R 17.5 / 215/75 R 17.5
- Axle load 25 t at 10 km/h

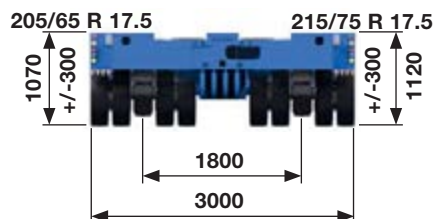
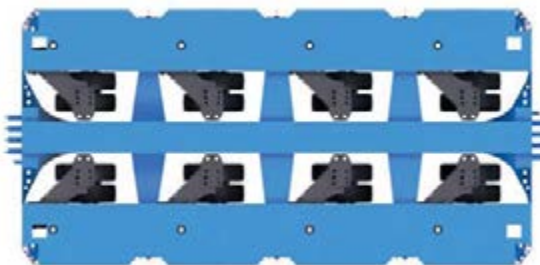
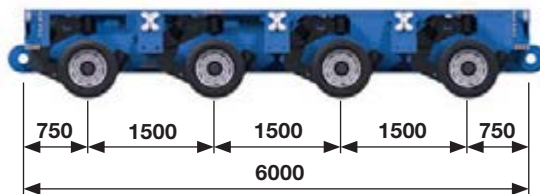

Heavy-duty modules with pivot bearings



# TYPE THP/MT

## OPTIMUM COMBINATION OF BENDING MOMENT AND LOADING HEIGHT

**Range of applications: Public roads and inside plant operations**

- Low loading height
- Optimum payload/axle load ratio

**Designed for concentrated loads and heavy-duty loads in the drop deck**

- Vehicle frame with high bending moment

**Technical features**

- Twin tires 215/75 R 17.5
- Axle load 25 t at 20 km/h

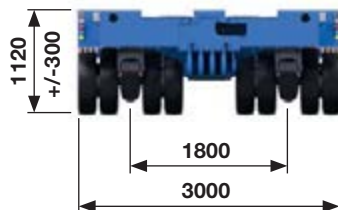
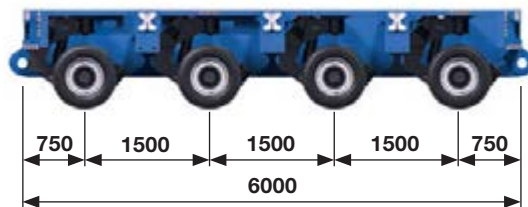



# PIVOT BEARING/BALL BEARING RACE RING INDIVIDUAL SOLUTIONS FOR SUCCESSFUL OPERATIONS

## PIVOT BEARING



**Vehicle types:**

- THP/ET
- THP/UT
- THP/MT

## BALL BEARING RACE RING



**Vehicle types:**

- THP/SL-S
- THP/SL-L
- THP/SL
- THP/MI
- THP/HL
- THP/H

Some of the above modules can be combined with one another. The modules can also be used with the same accessories, e.g. goosenecks, loading decks, turntable bolsters etc. for further savings.



Heavy-duty modules with ball bearing race rings





# TYPE THP/SL-S

## AS LIGHT AS POSSIBLE

**Range of applications: Public roads and construction site operations**

- Extremely low dead weight
- Big tires for off-road capability

**Designed for concentrated loads and heavy-duty loads in the drop deck**

- High bending moment

**Technical features**

- Single tires 245/70 R 17.5 for axle loads of 15.6t at 20 km/h
- Single tires 285/70 R 19.5 for axle loads of 23t at 10 km/h

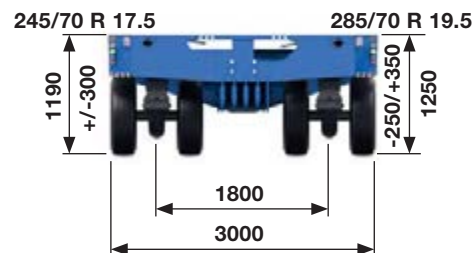
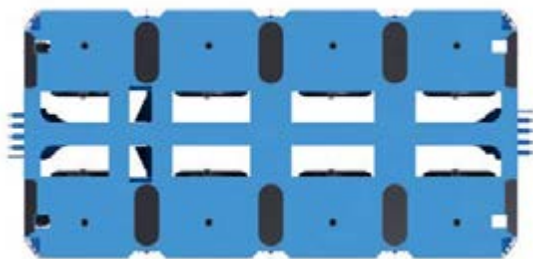
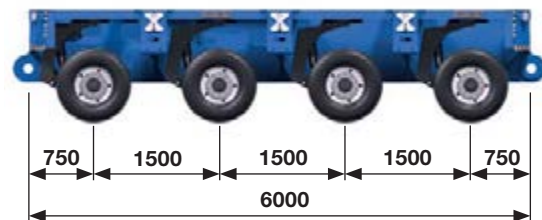

Heavy-duty modules with ball bearing race rings



# TYPE THP/SL-L

## MAKING LIGHT WORK OF HEAVY LOADS

### Range of applications: Public roads and inside plant operations

- Optimum payload/axle load ratio
- Torsion-resistant frame with closed loading platform

### Designed for concentrated loads and heavy-duty loads in the drop deck

- High bending moment

### Suitable for ultra-heavy loads

- Also for combination with THP/SL, PST/SL and PST/SL-E

### Technical features

- Twin tires 215/75 R 17.5
- Axle load 26.1 t at 20 km/h

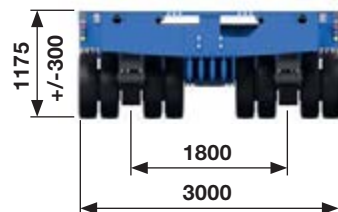
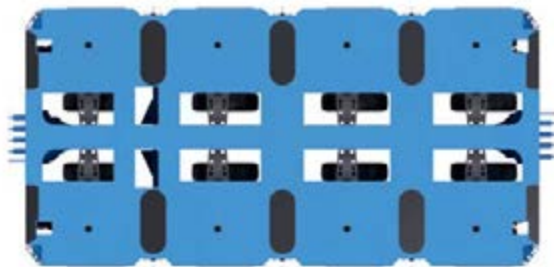
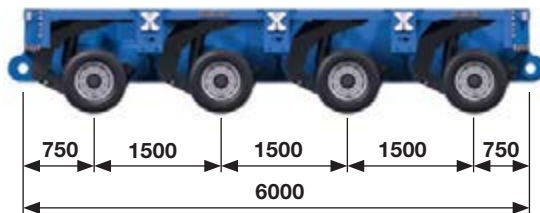

Heavy-duty modules with ball bearing race rings



# TYPE THP/SL

## HEAVY HAULAGE HAS A NAME

### THP/SL – THE ORIGINAL

**Range of applications: Public roads, construction site and inside plant operations**  
– Torsion-resistant frame with closed loading platform

**Designed for concentrated loads and heavy-duty loads in the drop deck**  
– High bending moment

**Suitable for ultra-heavy loads**  
– Also for combination with PST/SL and PST/SL-E

**Technical features**  
– Twin tires 215/75 R 17.5  
– Axle load 45 t at 1 km/h

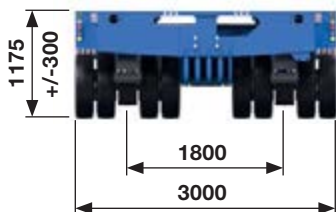
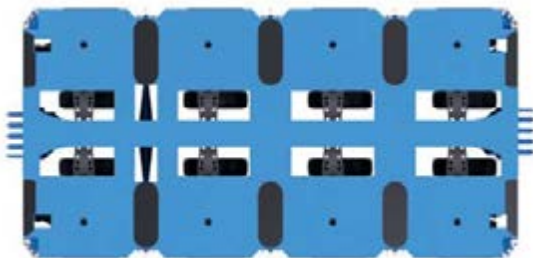
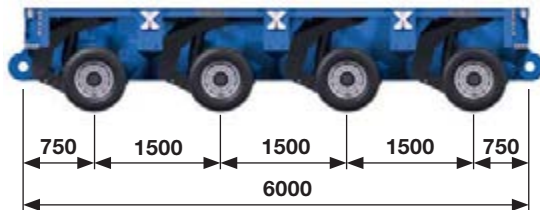

Special modules with ball bearing race rings



# TYPE THP/SL (1800) + THP/MI AN ENDLESS SUCCESS STORY

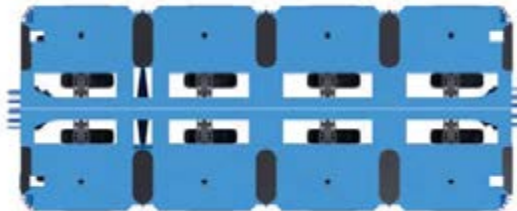
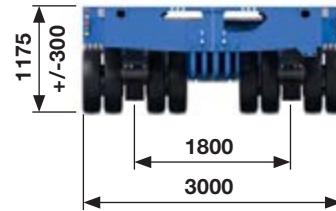
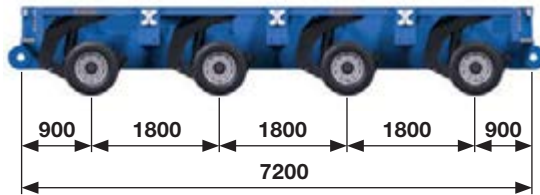

## THP/SL (1800)

- Range of applications: Split module for highway operations (hydraulic width adjustment optional)
- High bending moment for off-road transport
- Also for combination with PST/SL and PST/SL-E

## Technical features

- Twin tires 215/75 R 17.5
- Axle load 45 t at 1 km/h

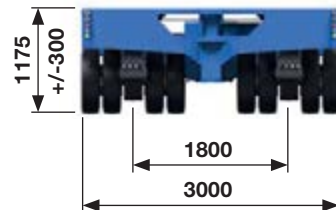
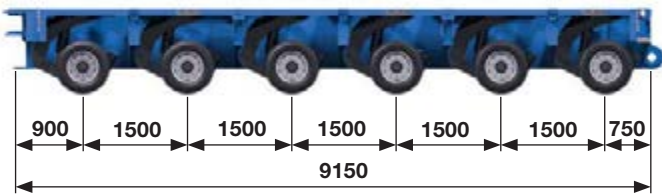

## THP/MI

- Range of applications: Cost-effective solution for highway operations with loads up to 400 t
- Also for combination with THP/SL, PST/SL and PST/SL-E

## Technical features

- Twin tires 215/75 R 17.5
- Axle load 28 t at 15 km/h

Special modules with ball bearing race rings





# TYPE THP/HL + THP/H

## NOTHING IS TOO HEAVY FOR THESE MODULES

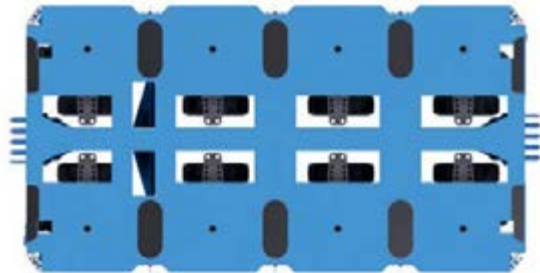
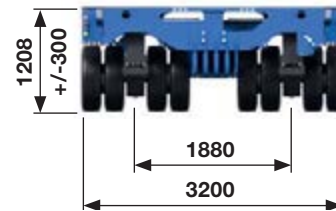
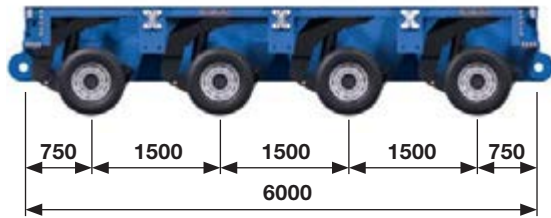

### THP/HL

- Range of applications: Choice of axle spacing for public roads
- High bending moment for off-road transport
- Also for combination with PST/SL and PST/SL-E

### Technical features

- Twin tires 245/75 R 17.5
- Axle load 45 t at 1 km/h

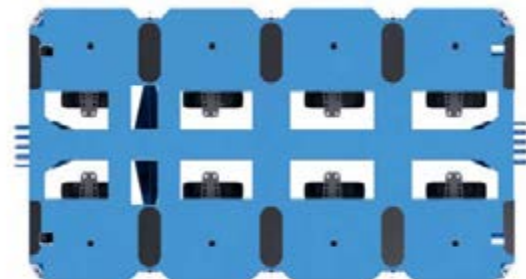
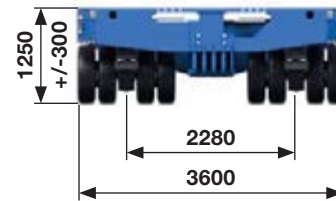
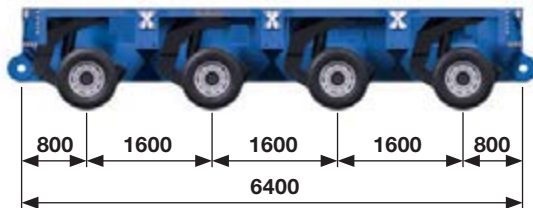

### THP/H

- Range of applications: Heavy-duty off-road operations with optimum lateral stability
- Optimized for mining operations etc.
- Also for combination with PST/H

### Technical features

- Twin tires 235/75 R 17.5
- Axle load 45 t at 5 km/h











# GOOSENECK WITH ALL OUR EXPERIENCE BEHIND IT

COMBINATION GOOSENECK

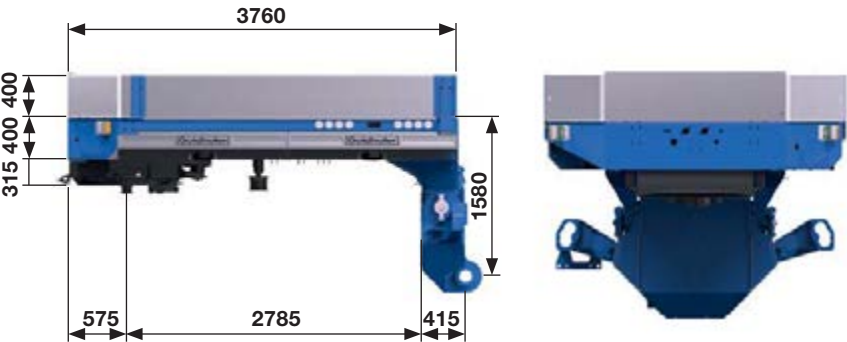

UNIVERSAL GOOSENECK

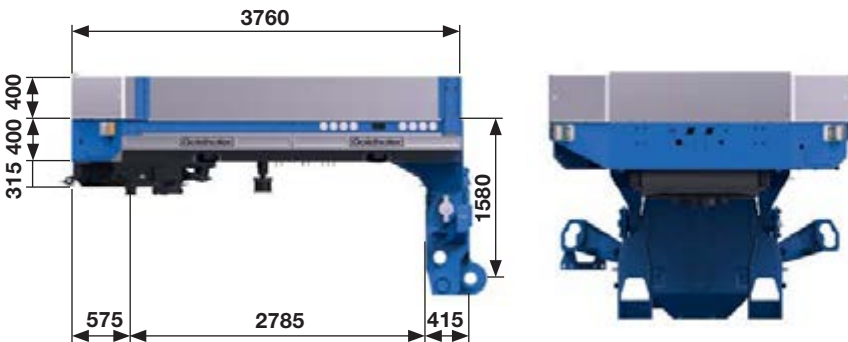





# LOADING DECKS

## FLEXIBILITY FOR EVERY LOAD

LOW-PROFILE DROP DECK



VESSEL BRIDGE



CRAWLER DECK



INTERMEDIATE PLATFORMS





# STANDARD THP ACCESSORIES + ACCESSORIES FOR SIDE-BY-SIDE COMBINATIONS THE BASIS OF A MODERN FLEET

STANDARD THP ACCESSORIES



SIDE-BY-SIDE COMBINATION ACCESSORIES



Drawbar



Swivel arm



Hydraulic power packs



Control panel



Radio remote for steering



Center pulling device P (1+1/2)



Center pulling device P (1+1)





# LONG-LOAD TURNTABLE AND LENGTH IS NO OBJECT

100 T/200 T TURNTABLE

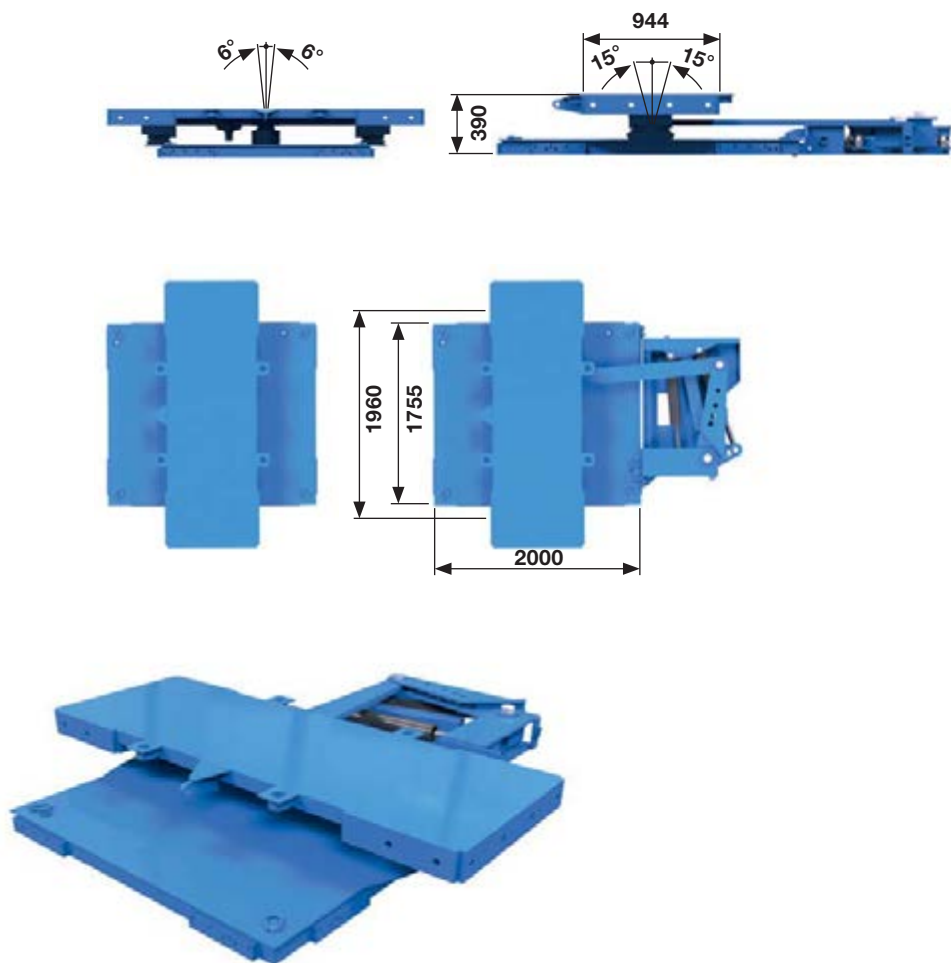

300 T/400 T TURNTABLE

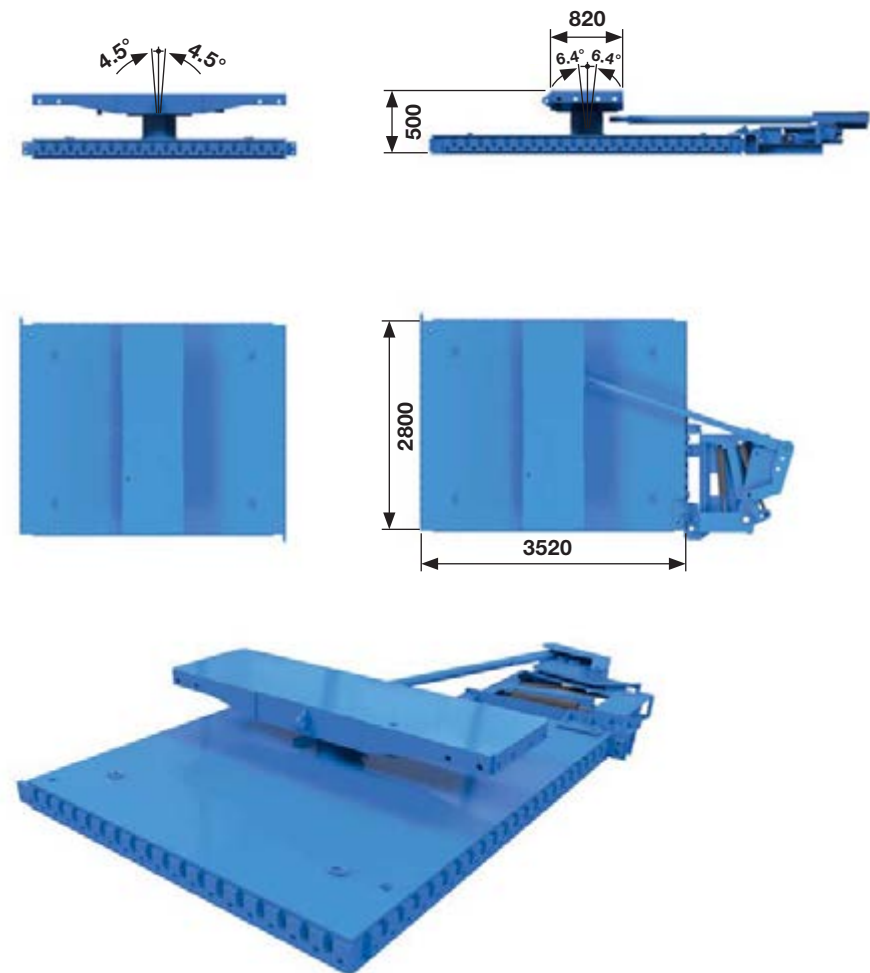

Heavy-duty modules with hydrostatic drive and mechanical steering



# TYPE PST/SL

## PACKS A PULL WHEN THE GOING GETS HEAVY

### Range of applications: Construction site and inside plant operations

- Robust, torsion-resistant frame with closed loading platform for concentrated loads
- High bending moment

### Universal configurations

- Also for combination with THP/SL-L and THP/SL
- Electronic synchronization with PST/H, PST/SL-E and PST/ES-E

### Maximum tractive force for optimum performance on gradients

- Tractive force 160kN per axle line

### Technical features

- Twin tires 215/75 R 17.5
- Axle load 45t at 1 km/h

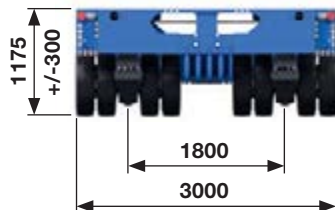
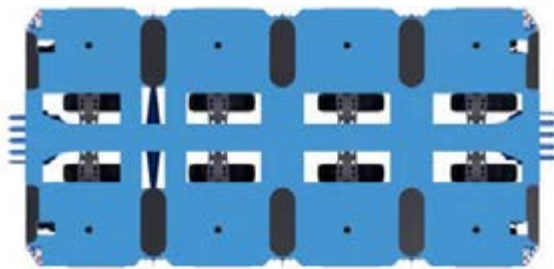
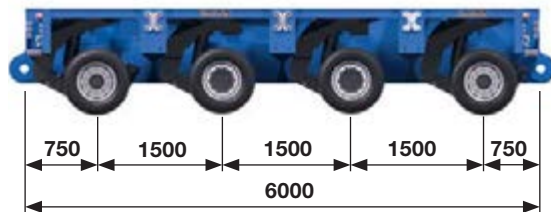

Heavy-duty modules with hydrostatic drive and mechanical steering





# TYPE PST/H

## THE SOLUTION FOR EXTREME CHALLENGES

### Range of applications: Construction site and inside plant operations

- Excellent lateral stability for mining operations etc.
- Robust, torsion-resistant frame with closed loading platform for concentrated loads
- High bending moment

### Universal configurations

- Also for combination with THP/H
- Electronic synchronization with PST/SL, PST/SL-E and PST/ES-E

### Maximum tractive force for optimum performance on gradients

- Tractive force 160 kN per axle line

### Technical features

- Twin tires 235/75 R 17.5
- Axle load 45 t at 5 km/h

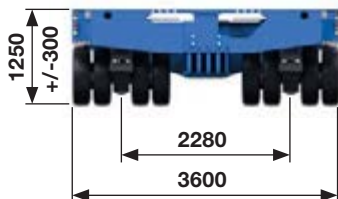
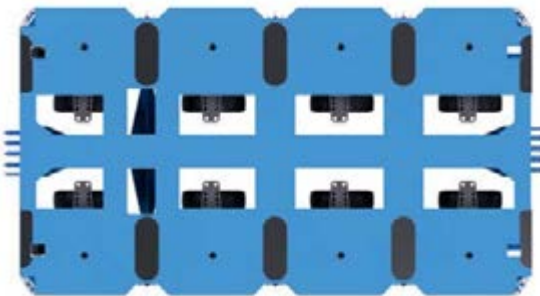
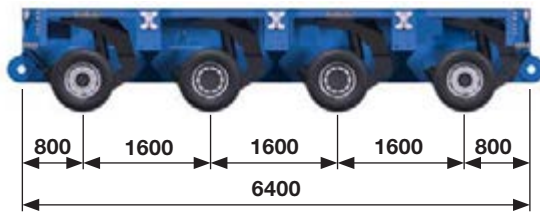





MAIN STEERING MODES  
PST/SL-E – PST/ES-E

1. Counter steering



4. Front axle steering

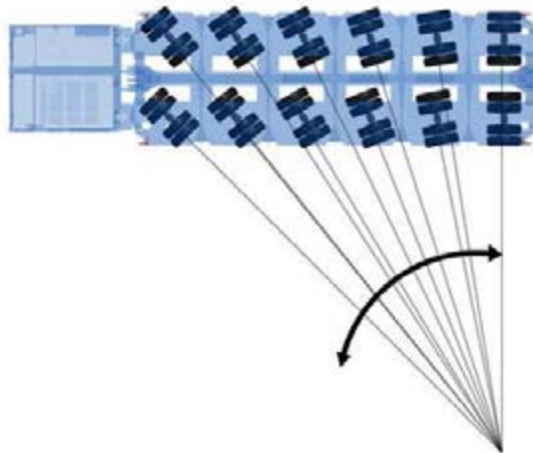

6. 90° crab steering

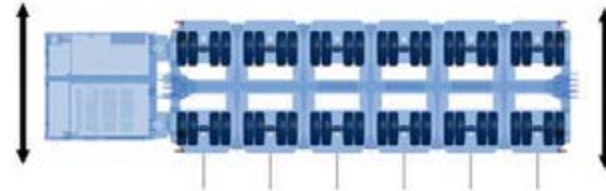

2. Carousel steering

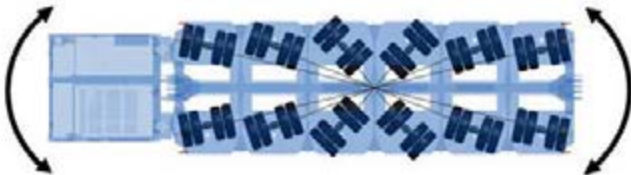

5. Rear axle steering

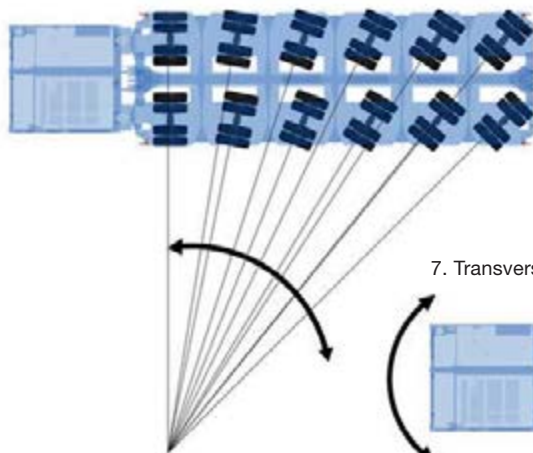

3. Crab steering

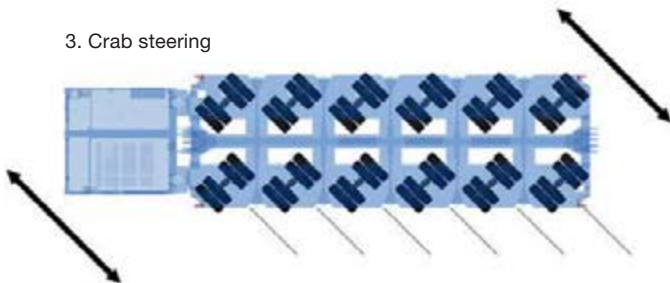

7. Transverse steering front/rear



# MAIN STEERING MODES PST/SL-E – PST/ES-E

1. Circle steering left/right

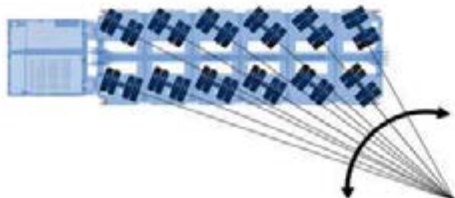

2. Carousel transverse steering

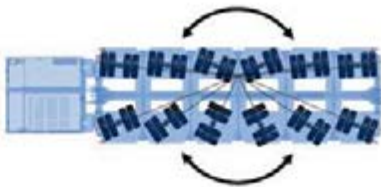

3. V combination

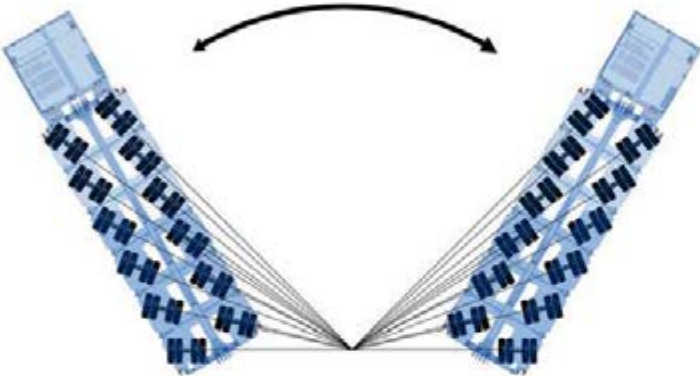

5. Free combination

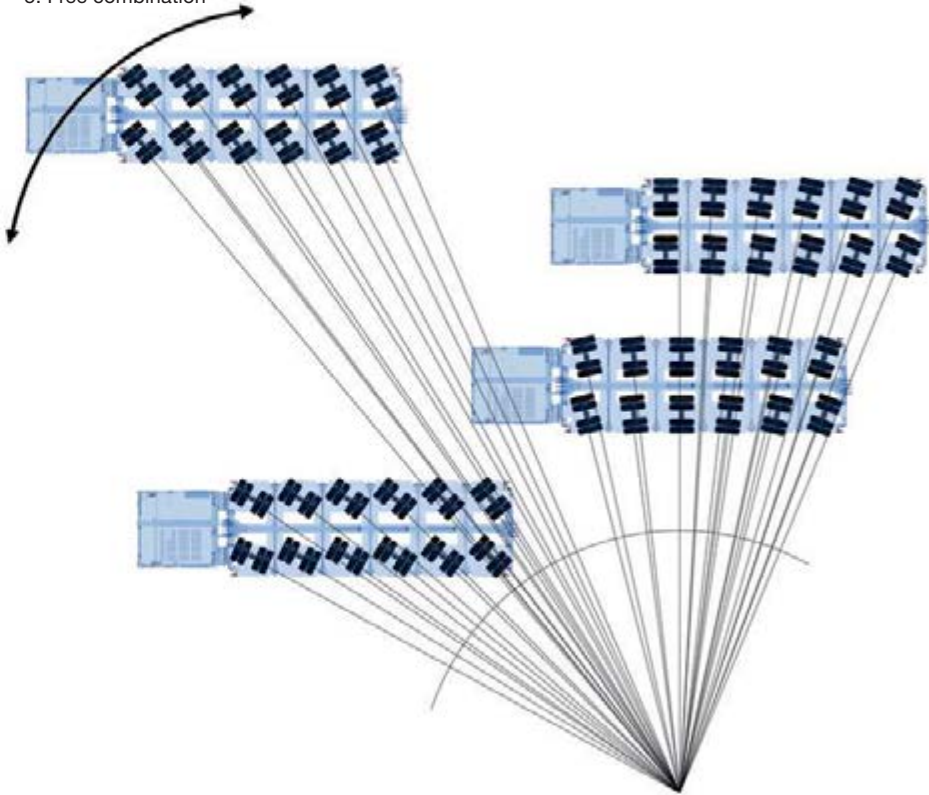

4. T combination

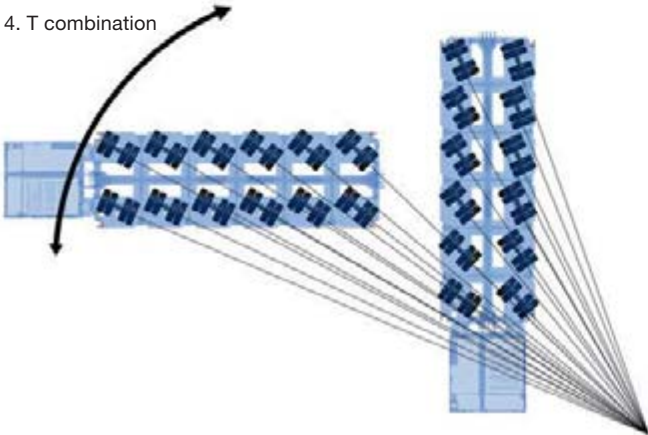

Heavy-duty modules with hydrostatic drive and electronic steering



# TYPE PST/SL-E

## PRECISION MANEUVERING WITH HEAVY LOADS

### Range of applications: Construction site and inside plant operations

- Robust, torsion-resistant frame with closed loading platform for concentrated loads
- High bending moment

### Universal configurations

- Also for combination with THP/SL-L and THP/SL
- Electronic synchronization with PST/SL, PST/H and PST/ES-E

### Optimum maneuverability

- Electronic multiway steering +/- 135°

### Maximum tractive force for optimum performance on gradients

- Tractive force 160 kN per axle line

### Technical features

- Twin tires 215/75 R 17.5
- Axle load 45t at 1 km/h

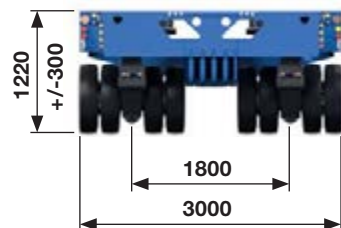
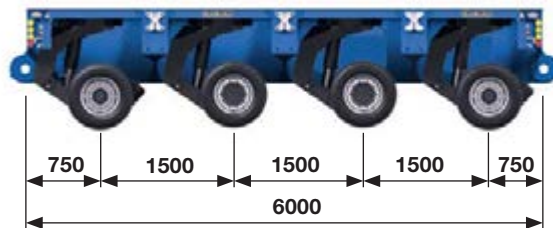

Heavy-duty modules with hydrostatic drive and electronic steering





# TYPE PST/ES-E

## IDEAL COMBINATION OF PAYLOAD AND FLEXIBILITY



### Range of applications: Construction site and inside plant operations

- Electronic multiway steering +/- 135° for precise load positioning
- Optimum payload/axle load ratio
- Torsion-resistant frame with closed loading platform and with high bending moment
- Wider track for improved side stability
- Excellent tractive force for optimum performance on gradients
- Optimized max. speeds empty and fully laden

#### Technical features PST/ES-E (285)

- Single tires 285/70 R 19.5
- Axle load 40 t at 0.4 km/h
- Vehicle width 2430 mm/2730 mm
- Tractive force 165 kN per axle line

#### Technical features PST/ES-E (315)

- Single tires 315/60 R 22.5
- Axle load 45 t at 1 km/h
- Vehicle width 2430 mm
- Tractive force 153 kN per axle line

#### Technical features PST/ES-E (385)

- Single tires 385/55 R 22.5
- Axle load 60 t at 1 km/h
- Vehicle width 2430 mm
- Tractive force 160 kN per axle line

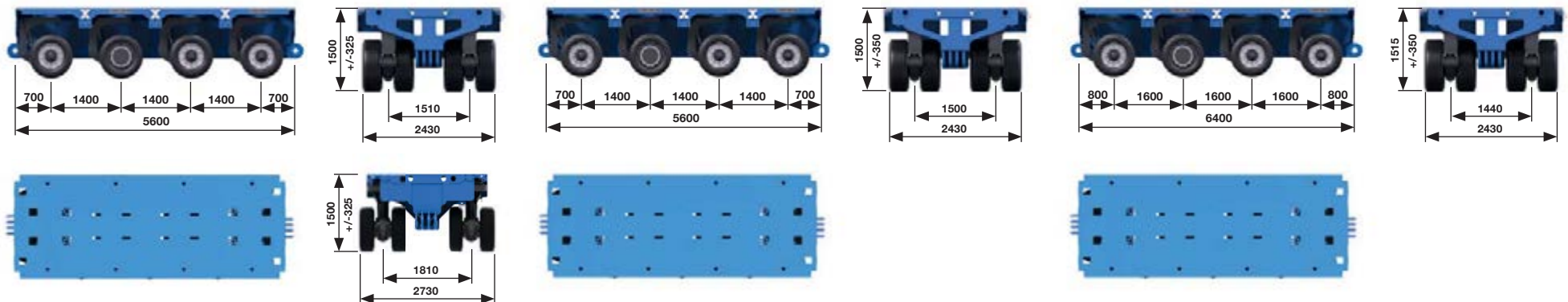







# POWER PACKS

## POWER FOR THE BIGGEST JOBS

155 KW DEUTZ POWER PACK  
(TIER 3) 2400 mm



207 KW CUMMINS POWER PACK  
(TIER 4 FINAL) 2400 mm (HYBRID OPTIONAL)



360 KW DEUTZ POWER PACK  
(TIER 3) 2400 mm/3000 mm



390 KW DEUTZ POWER PACK  
(TIER 4 FINAL) 2400 mm/3000 mm





# STANDARD ACCESSORIES FOR SAFE AND SIMPLE WORKING

REMOTE CONTROL



Radio remote



Cable remote



Emergency cable remote

DRIVER'S CAB/FRONT BUMPER







# OUR TOOLS FOR QUICK AND EASY TRANSPORT ENGINEERING

easyVERSION

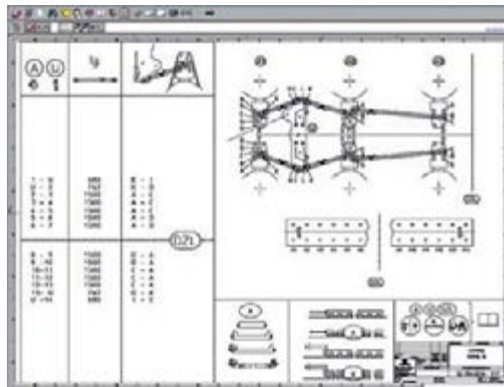

easyLOAD



easyTRACK

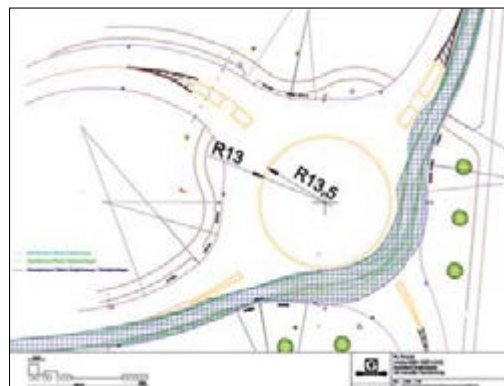

MULTIWAYdata



Service

# **GOLDHOFER – THE ORIGINAL BENCHMARK SERVICE FOR HEAVY HAULAGE ANY TIME AND ANY PLACE**



Service

# NO PROBLEM!

## SERVICE

- 24-hour emergency service
- Worldwide service partner network

## SPARE PARTS

- Fast availability
- Global distribution
- Electronic online spare parts catalog

## TRANSPORT ENGINEERING

- Operations planning software
- Route analysis
- Escort services and service engineering

## REPAIRS

- Maintenance and repair work
- Vehicle overhauls
- Mobile workshop
- Temporary replacement vehicles
- In-house repair shop
- Over 70 service points in Europe

## TRAINING ON-SITE OR AT OUR TRAINING FACILITY

- For vehicle operators
- For maintenance staff
- For load security



## SERVICE ADVANTAGES

- ✓ 24-hour service
- ✓ Worldwide service organization
- ✓ Worldwide parts supply
- ✓ Technical support and operations consulting
- ✓ Training on-site or at our training facility

**GOLDHOFER AKTIENGESELLSCHAFT**

Donaustraße 95, 87700 Memmingen/Germany  
Phone: +49 8331 15-0, Fax: +49 8331 15-239  
Web: [www.goldhofer.de](http://www.goldhofer.de)  
E-mail: [info@goldhofer.de](mailto:info@goldhofer.de)

**VERKAUF | SALES**

**Transport Technology**  
Phone Trailer/Semitrailer: +49 8331 15-341  
Phone Modular Trailer: +49 8331 15-342  
E-mail: [sales@goldhofer.de](mailto:sales@goldhofer.de)

**SERVICE | SERVICE  
ERSATZTEILE | SPARE PARTS**

**Transport Technology**  
Phone: +49 8331 15-400  
Fax: +49 8331 15-247  
E-mail: [service@goldhofer.de](mailto:service@goldhofer.de)